

# ***TPS54614EVM, 1.8-V Swift™ Regulator Evaluation Module***

## *User's Guide*

## IMPORTANT NOTICE

Texas Instruments Incorporated and its subsidiaries (TI) reserve the right to make corrections, modifications, enhancements, improvements, and other changes to its products and services at any time and to discontinue any product or service without notice. Customers should obtain the latest relevant information before placing orders and should verify that such information is current and complete. All products are sold subject to TI's terms and conditions of sale supplied at the time of order acknowledgment.

TI warrants performance of its hardware products to the specifications applicable at the time of sale in accordance with TI's standard warranty. Testing and other quality control techniques are used to the extent TI deems necessary to support this warranty. Except where mandated by government requirements, testing of all parameters of each product is not necessarily performed.

TI assumes no liability for applications assistance or customer product design. Customers are responsible for their products and applications using TI components. To minimize the risks associated with customer products and applications, customers should provide adequate design and operating safeguards.

TI does not warrant or represent that any license, either express or implied, is granted under any TI patent right, copyright, mask work right, or other TI intellectual property right relating to any combination, machine, or process in which TI products or services are used. Information published by TI regarding third-party products or services does not constitute a license from TI to use such products or services or a warranty or endorsement thereof. Use of such information may require a license from a third party under the patents or other intellectual property of the third party, or a license from TI under the patents or other intellectual property of TI.

Reproduction of information in TI data books or data sheets is permissible only if reproduction is without alteration and is accompanied by all associated warranties, conditions, limitations, and notices. Reproduction of this information with alteration is an unfair and deceptive business practice. TI is not responsible or liable for such altered documentation.

Resale of TI products or services with statements different from or beyond the parameters stated by TI for that product or service voids all express and any implied warranties for the associated TI product or service and is an unfair and deceptive business practice. TI is not responsible or liable for any such statements.

### Mailing Address:

Texas Instruments  
Post Office Box 655303  
Dallas, Texas 75265

## EVM IMPORTANT NOTICE

Texas Instruments (TI) provides the enclosed product(s) under the following conditions:

This evaluation kit being sold by TI is intended for use for **ENGINEERING DEVELOPMENT OR EVALUATION PURPOSES ONLY** and is not considered by TI to be fit for commercial use. As such, the goods being provided may not be complete in terms of required design-, marketing-, and/or manufacturing-related protective considerations, including product safety measures typically found in the end product incorporating the goods. As a prototype, this product does not fall within the scope of the European Union directive on electromagnetic compatibility and therefore may not meet the technical requirements of the directive.

Should this evaluation kit not meet the specifications indicated in the EVM User's Guide, the kit may be returned within 30 days from the date of delivery for a full refund. THE FOREGOING WARRANTY IS THE EXCLUSIVE WARRANTY MADE BY SELLER TO BUYER AND IS IN LIEU OF ALL OTHER WARRANTIES, EXPRESSED, IMPLIED, OR STATUTORY, INCLUDING ANY WARRANTY OF MERCHANTABILITY OR FITNESS FOR ANY PARTICULAR PURPOSE.

The user assumes all responsibility and liability for proper and safe handling of the goods. Further, the user indemnifies TI from all claims arising from the handling or use of the goods. Please be aware that the products received may not be regulatory compliant or agency certified (FCC, UL, CE, etc.). Due to the open construction of the product, it is the user's responsibility to take any and all appropriate precautions with regard to electrostatic discharge.

EXCEPT TO THE EXTENT OF THE INDEMNITY SET FORTH ABOVE, NEITHER PARTY SHALL BE LIABLE TO THE OTHER FOR ANY INDIRECT, SPECIAL, INCIDENTAL, OR CONSEQUENTIAL DAMAGES.

TI currently deals with a variety of customers for products, and therefore our arrangement with the user **is not exclusive**.

TI assumes **no liability for applications assistance, customer product design, software performance, or infringement of patents or services described herein**.

Please read the EVM User's Guide and, specifically, the EVM Warnings and Restrictions notice in the EVM User's Guide prior to handling the product. This notice contains important safety information about temperatures and voltages. For further safety concerns, please contact the TI application engineer.

Persons handling the product must have electronics training and observe good laboratory practice standards.

No license is granted under any patent right or other intellectual property right of TI covering or relating to any machine, process, or combination in which such TI products or services might be or are used.

Mailing Address:

Texas Instruments  
Post Office Box 655303  
Dallas, Texas 75265

## **EVM WARNINGS AND RESTRICTIONS**

It is important to operate this EVM within the specified input and output ranges described in the EVM User's Guide.

Exceeding the specified input range may cause unexpected operation and/or irreversible damage to the EVM. If there are questions concerning the input range, please contact a TI field representative prior to connecting the input power.

Applying loads outside of the specified output range may result in unintended operation and/or possible permanent damage to the EVM. Please consult the EVM User's Guide prior to connecting any load to the EVM output. If there is uncertainty as to the load specification, please contact a TI field representative.

During normal operation, some circuit components may have case temperatures greater than 60°C. The EVM is designed to operate properly with certain components above 60°C as long as the input and output ranges are maintained. These components include but are not limited to linear regulators, switching transistors, pass transistors, and current sense resistors. These types of devices can be identified using the EVM schematic located in the EVM User's Guide. When placing measurement probes near these devices during operation, please be aware that these devices may be very warm to the touch.

### Mailing Address:

Texas Instruments  
Post Office Box 655303  
Dallas, Texas 75265

# Read This First

---

---

---

### ***About This Manual***

This users guide describes the characteristics, operation, and use of the TPS54614 1.8-V SWIFT™ regulator evaluation module (EVM). The users guide includes a schematic diagram and bill of materials.

### ***How to Use This Manual***

This document contains the following chapters:

- Chapter 1—Introduction
- Chapter 2—Setup and Test Results
- Chapter 3—Board Layout
- Chapter 4—Schematic and Bill of Materials

### ***FCC Warning***

This equipment is intended for use in a laboratory test environment only. It generates, uses, and can radiate radio frequency energy and has not been tested for compliance with the limits of computing devices pursuant to subpart J of part 15 of FCC rules, which are designed to provide reasonable protection against radio frequency interference. Operation of this equipment in other environments may cause interference with radio communications, in which case the user at his own expense will be required to take whatever measures may be required to correct this interference.

### ***Trademarks***

SWIFT™ is a trademark of Texas Instruments.



# Contents

---

---

---

<b>1</b>	<b>Introduction</b> .....	<b>1-1</b>
1.1	Background .....	1-2
1.2	Performance Specification Summary .....	1-2
1.3	Modifications .....	1-3
<b>2</b>	<b>Setup and Test Results</b> .....	<b>2-1</b>
2.1	Input/Output Connections .....	2-2
2.2	Efficiency .....	2-3
2.3	Thermal Performance .....	2-4
2.4	Output Voltage Regulation .....	2-5
2.5	Load Transients .....	2-6
2.6	Loop Characteristics .....	2-7
2.7	Output Voltage Ripple .....	2-8
2.8	Input Voltage Ripple .....	2-9
2.9	Start-Up .....	2-10
<b>3</b>	<b>Board Layout</b> .....	<b>3-1</b>
3.1	Layout .....	3-2
<b>4</b>	<b>Schematic and Bill of Materials</b> .....	<b>4-1</b>
4.1	Schematic .....	4-2
4.2	Bill of Materials .....	4-3

# Figures

---

---

---

2-1	Test Setup Connection Diagram .....	2-2
2-2	Measured Efficiency .....	2-3
2-3	Measured Board Losses .....	2-3
2-4	Measured Junction Temperature at 25°C Ambient .....	2-4
2-5	Measured Case Temperature at 25°C Ambient .....	2-4
2-6	Measured Load Regulation .....	2-5
2-7	Measured Load Transient Response .....	2-6
2-8	Measured Negative Load Transient Response .....	2-6
2-9	Measured Loop Gain .....	2-7
2-10	Measured Loop Phase .....	2-7
2-11	Measured Output Voltage Ripple With 3.3-V Input .....	2-8
2-12	Measured Output Voltage Ripple With 5.0-V Input .....	2-8
2-13	Measured Input Ripple Voltage With 3.3-V Input .....	2-9
2-14	Measured Input Ripple Voltage With 5.0-V Input .....	2-9
2-15	Measured Start-Up Waveforms .....	2-10
3-1	Top-Side Assembly .....	3-2
3-2	Top-Side Layout .....	3-3
3-3	Internal Layers Layout .....	3-4
3-4	Bottom Side Layout .....	3-5
4-1	EVM Schematic .....	4-2

# Tables

---

---

---

1-1	Performance Specification Summary .....	1-2
1-2	Modification Table .....	1-3
4-1	TPS54614 EVM Bill of Materials .....	4-3



# Introduction

---

---

---

---

This chapter contains background information for the TPS54614 and support documentation for the TPS54614 EVM evaluation module. The TPS54614 EVM performance specifications are given, as well as modification instructions if different preset output voltages are desired.

<b>Topic</b>	<b>Page</b>
<b>1.1 Background</b> .....	<b>1-2</b>
<b>1.2 Performance Specification Summary</b> .....	<b>1-2</b>
<b>1.3 Modifications</b> .....	<b>1-3</b>

## 1.1 Background

The TPS54614 evaluation module uses the TPS54614 synchronous buck regulator to provide a 1.8-V output. This voltage is maintained over an input range of 3.0 V to 6.0 V, and over a load range of 0 A to 6 A. The TPS54614 EVM circuitry contains only seven electrical components covering an area less than one square inch.

The TPS54614 has two key features that reduce the number of additional components compared to traditional synchronous buck controllers. The first feature is that the MOSFETs are incorporated inside the TPS54614 package. This eliminates the need for external MOSFETs and their associated drivers. The second feature is that the compensation components that stabilize the feedback loop are also incorporated inside the TPS54614 package.

Because the internal compensation of the TPS54614 is fixed, loop stability is assured by the proper selection of an output inductor and output capacitor. For guidelines on selecting an output inductor and output capacitor for a specific application, refer to Texas Instruments application report *SLVA105 – Designing With Internally Compensated SWIFT™ Regulators*.

## 1.2 Performance Specification Summary

A summary of the TPS54614EVM performance specifications is provided by Table 1–1. All specifications are given for an ambient temperature of 25°C, unless otherwise noted.

Table 1–1. Performance Specification Summary

Specification	Test Conditions	Min	Typ	Max	Units
Input voltage range	$I_O = 6\text{ A}$	3	5	6	V
Output voltage set point			1.8		V
Output current range		0		> 6	A
Line regulation	$I_O = 6\text{ A}$	–5		+5	mV
Load regulation	$V_{IN} = 5\text{ V}$	–9		+9	mV
Load transient response	$I_O = 1.5\text{ A to }4.5\text{ A}, t_f = 16\ \mu\text{s}$		–80		mV <sub>PK</sub>
			50		$\mu\text{s}$
	$I_O = 4.5\text{ A to }1.5\text{ A}, t_f = 12\ \mu\text{s}$		55		mV <sub>PK</sub>
			50		$\mu\text{s}$
Loop bandwidth	$V_{IN} = 5\text{ V}, I_O = 6\text{ A}$		50		kHz
Phase margin	$V_{IN} = 5\text{ V}, I_O = 6\text{ A}$		46		°
Input ripple voltage				270	mV <sub>pp</sub>
Output ripple voltage			10	18	mV <sub>pp</sub>
Output rise time			3.6		ms
Operating frequency		440	550	660	kHz
Efficiency	$V_{IN} = 5\text{ V}, I_O = 1.5\text{ A}$		91%		

### 1.3 Modifications

The EVM can be modified for different preset output voltages by using other devices in the TPS5461x family. For output voltages less than 2.5 V, only U1 needs to be changed. For output voltages 2.5 V and higher, the output capacitor (C1) also needs to be changed. Table 1–2 lists the devices required for U1 and C1 for different output voltage options.

Table 1–2. Modification Table

Output Voltage (V)	SWIFT™ Device (U1)	Output Capacitor (C1)
0.9	TPS54611	Sanyo – 2R5TPB680M
1.2	TPS54612	Sanyo – 2R5TPB680M
1.5	TPS54613	Sanyo – 2R5TPB680M
1.8	TPS54614	Sanyo – 2R5TPB680M
2.5	TPS54615	Sanyo – 4TPB470M
3.3	TPS54616	Sanyo – 4TPB470M



# Setup and Test Results

---

---

---

---

This chapter describes how to properly connect, set up, and use the TPS54614 EVM. This chapter also presents the test results for the TPS54614, and covers efficiency, output voltage regulation, load transients, loop response, output ripple, and start-up.

<b>Topic</b>	<b>Page</b>
<b>2.1 Input/Output Connections</b> .....	<b>2-2</b>
<b>2.2 Efficiency</b> .....	<b>2-3</b>
<b>2.3 Thermal Performance</b> .....	<b>2-4</b>
<b>2.4 Output Voltage Regulation</b> .....	<b>2-5</b>
<b>2.5 Load Transients</b> .....	<b>2-6</b>
<b>2.6 Loop Characteristics</b> .....	<b>2-7</b>
<b>2.7 Output Voltage Ripple</b> .....	<b>2-8</b>
<b>2.8 Input Voltage Ripple</b> .....	<b>2-9</b>
<b>2.9 Start-Up</b> .....	<b>2-10</b>

## 2.1 Input/Output Connections

The TPS54614 has the following four input/output connections: input, input return, output, and output return. A diagram showing the connection points is shown in Figure 2–1. Connect a power supply capable of supplying 5 A to J1 through a pair of 20 AWG wires. Connect the load to J2 through a pair of 16 AWG wires. Wire lengths should be minimized on both the input and output connections.

Figure 2–1. Test Setup Connection Diagram

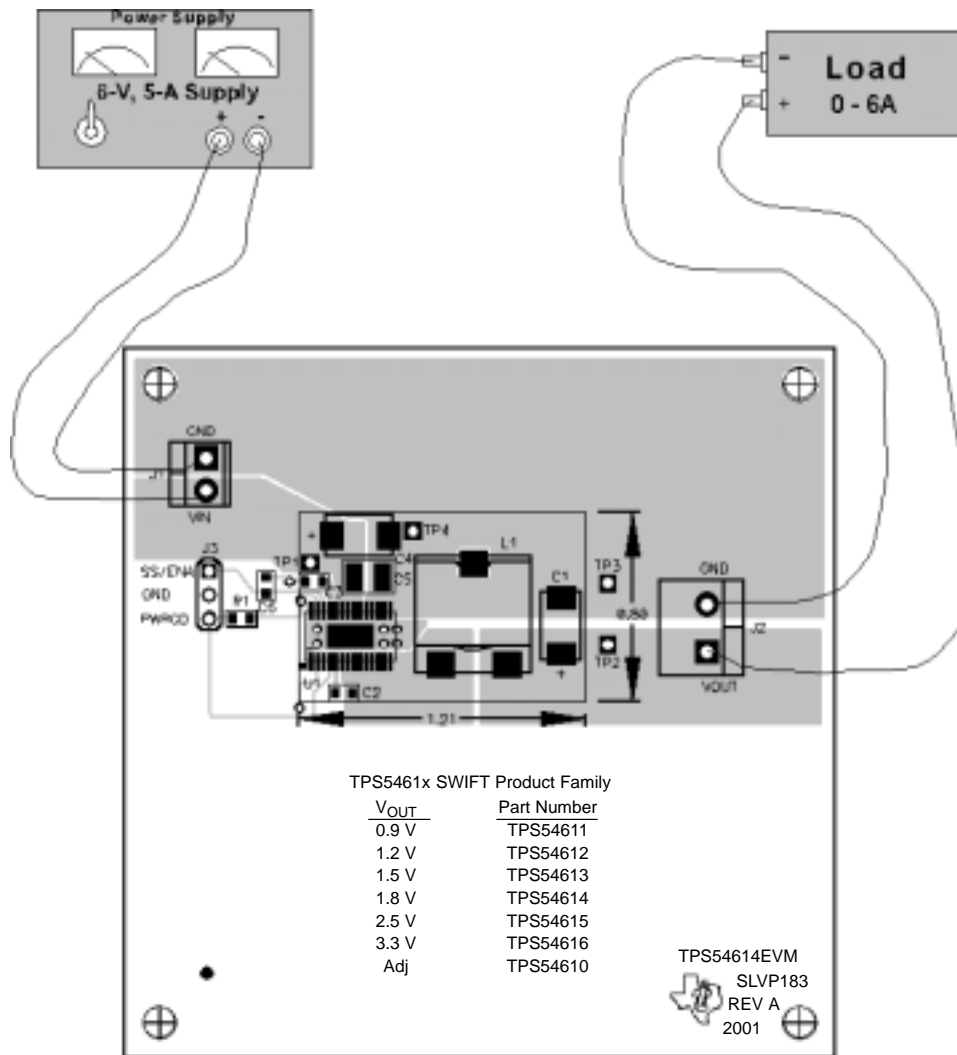

NOTE: All wire pairs should be twisted.

## 2.2 Efficiency

The TPS54614 efficiency peaks at around 1.5 A of load current. At a full 6-A load the efficiency drops to around 83% with a 5-V input source. The efficiency shown in Figure 2–2 is typical for an ambient temperature of 25°C. The efficiency is lower at higher ambient temperatures, due to temperature variation in the drain-to-source resistance of the MOSFETs. The total board losses are shown in Figure 2–3. The plots of Figure 2–4 and Figure 2–5 are extended out to current levels where the TPS54614 junction temperature reaches 125°C at 25°C ambient. When operating the TPS54614 past the 6-A maximum current rating, care should be taken to ensure that the maximum junction temperature does not exceed 125°C.

Figure 2–2. Measured Efficiency

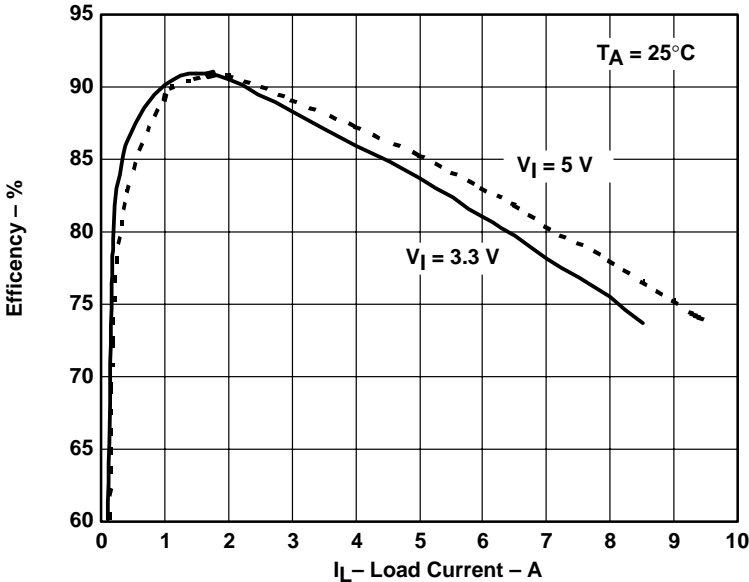
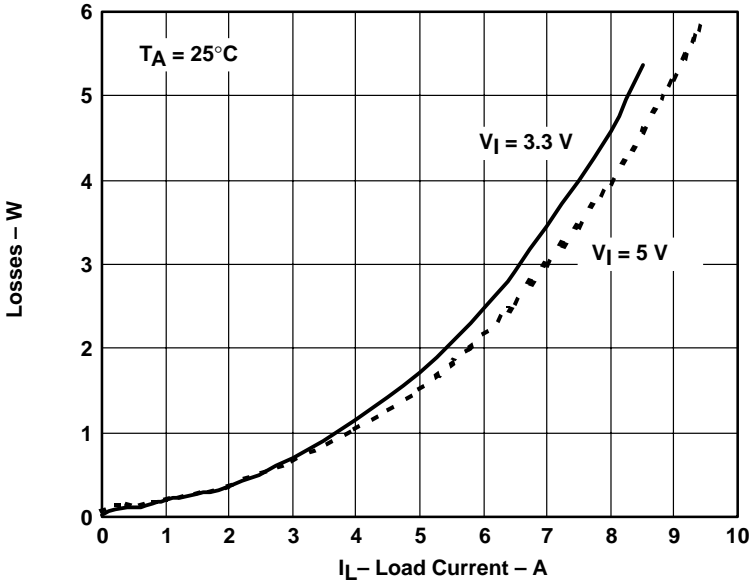

Figure 2–3. Measured Board Losses



### 2.3 Thermal Performance

The plot in Figure 2–4 shows the junction temperature versus the load current at 25°C ambient temperature. The case temperature is plotted in Figure 2–5. The low junction-to-case thermal resistance of the PWP package, along with a good board layout, helps to keep the junction temperature low at high output currents. With a 3.3-V input source and a 6-A load, the junction temperature is approximately 65°C, while the case temperature is approximately 59°C.

Figure 2–4. Measured Junction Temperature at 25°C Ambient

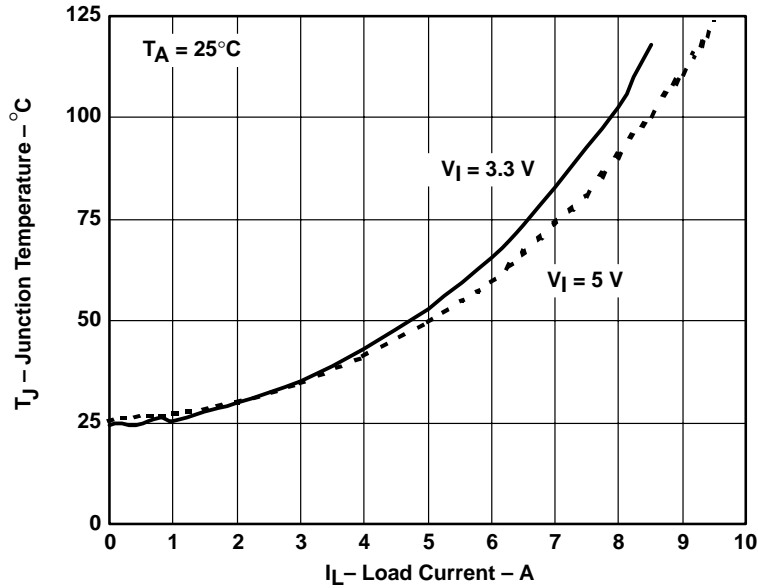
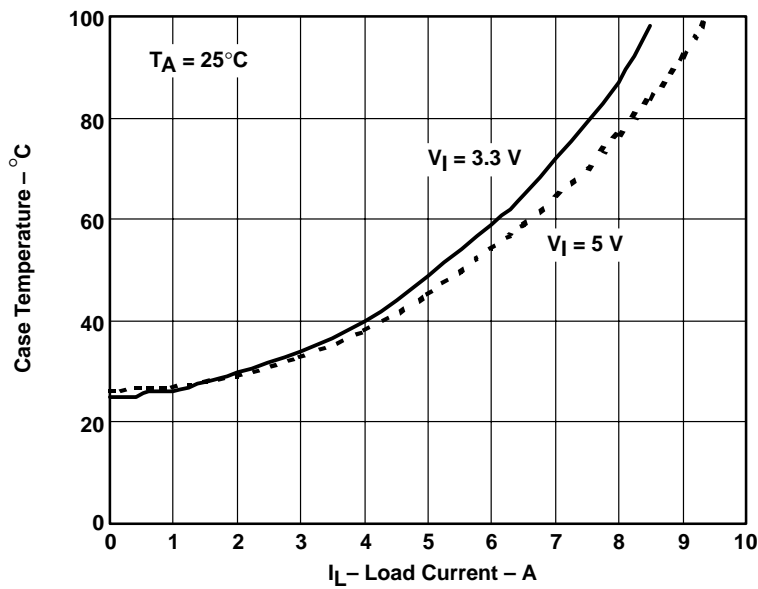

Figure 2–5. Measured Case Temperature at 25°C Ambient





## 2.4 Output Voltage Regulation

The output voltage load regulation at 25°C is shown in Figure 2–6. The output voltage varies less than 0.3% over the entire input voltage range of 3.3 V to 5.0 V, and load range of 0 A to 6 A.

Figure 2–6. Measured Load Regulation

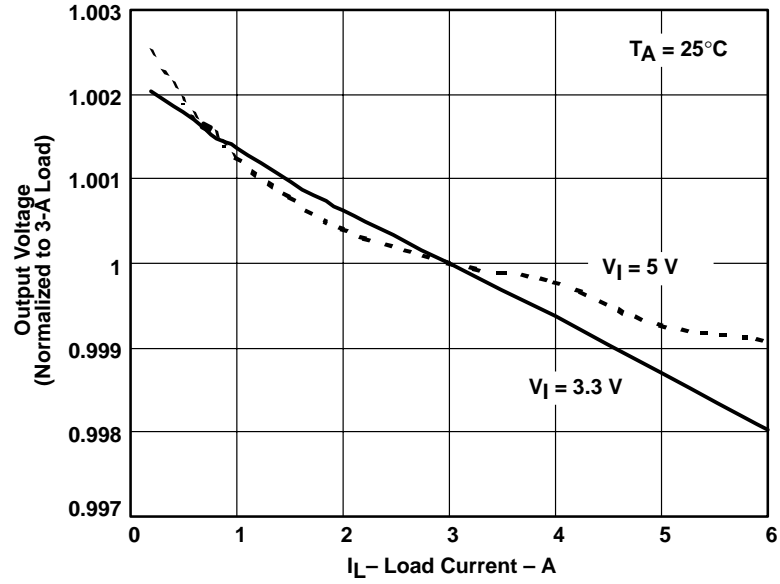

## 2.5 Load Transients

The TPS54614 EVM response to load transients is shown in Figure 2–7 and Figure 2–8. The load transient in Figure 2–7 transitions from 1.5 A to 4.5 A in 16  $\mu$ s, while the load transient in Figure 2–8 transitions from 4.5 A to 1.5 A in 12  $\mu$ s. The transient response can be improved at the cost of adding additional capacitance to the output.

Figure 2–7. Measured Load Transient Response

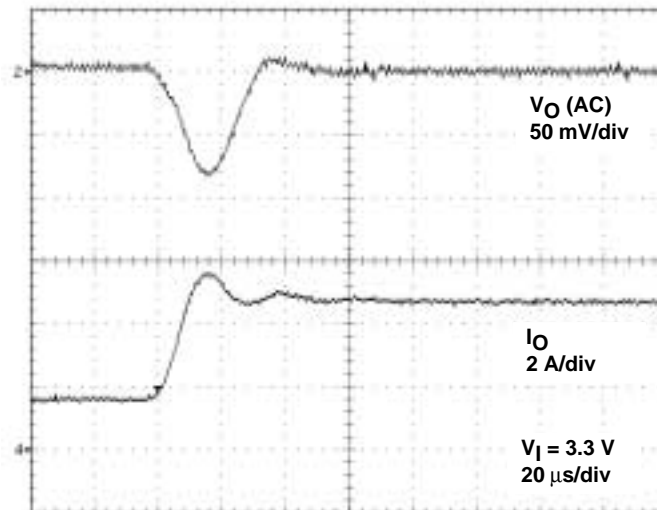
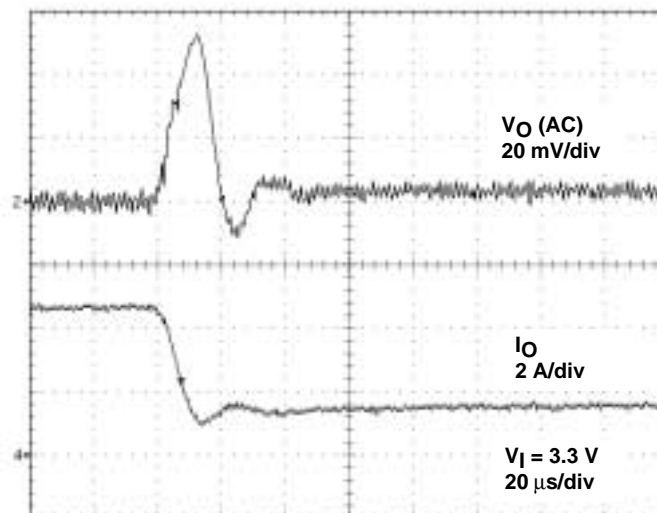

Figure 2–8. Measured Negative Load Transient Response



## 2.6 Loop Characteristics

The loop gain and phase for a 5.0-V input and a 6.0-A load are shown in Figure 2–9 and Figure 2–10. The loop crossover frequency is approximately 50 kHz, and the phase margin is approximately 46°.

Figure 2–9. Measured Loop Gain

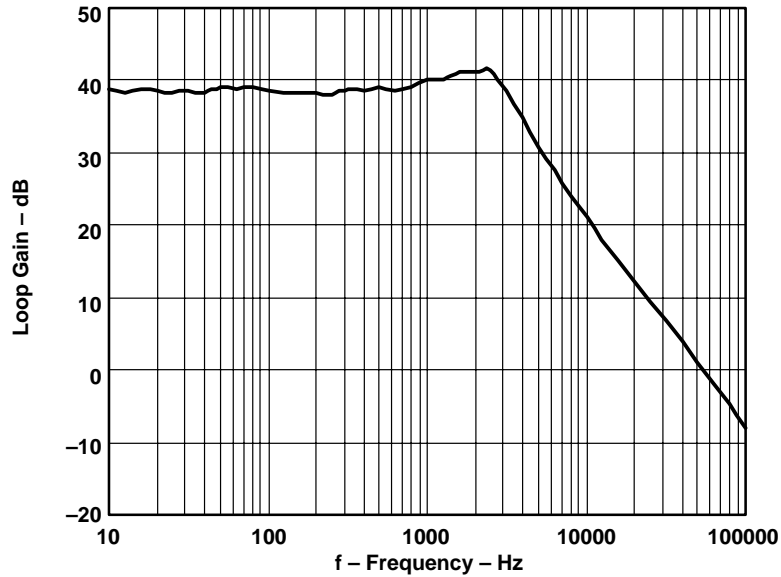
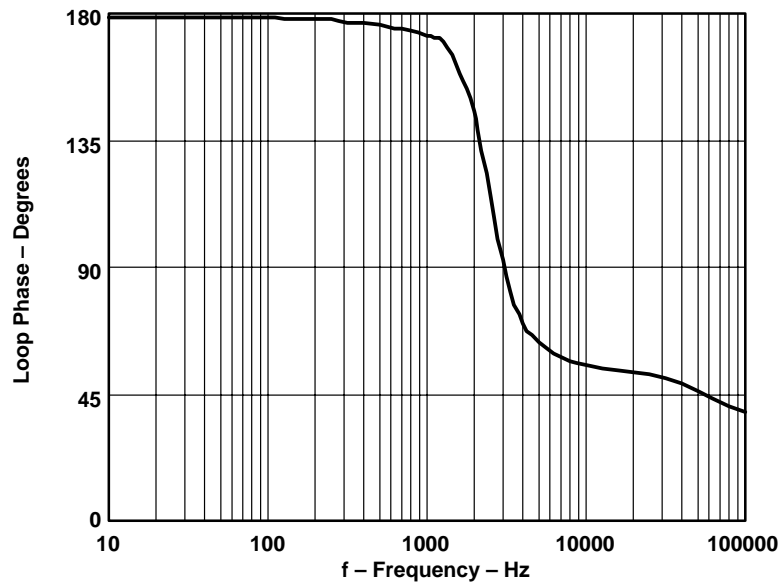

Figure 2–10. Measured Loop Phase



## 2.7 Output Voltage Ripple

The output ripple voltage is plotted in Figure 2–11 for a 3.3-V input, and in Figure 2–12 for a 5.0-V input. The TPS54614 has a typical output voltage ripple of less than 15 mV<sub>pp</sub>.

Figure 2–11. Measured Output Voltage Ripple With 3.3-V Input

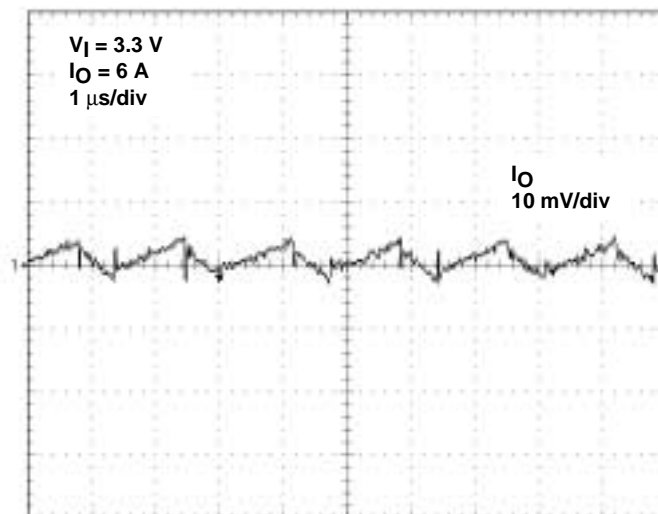
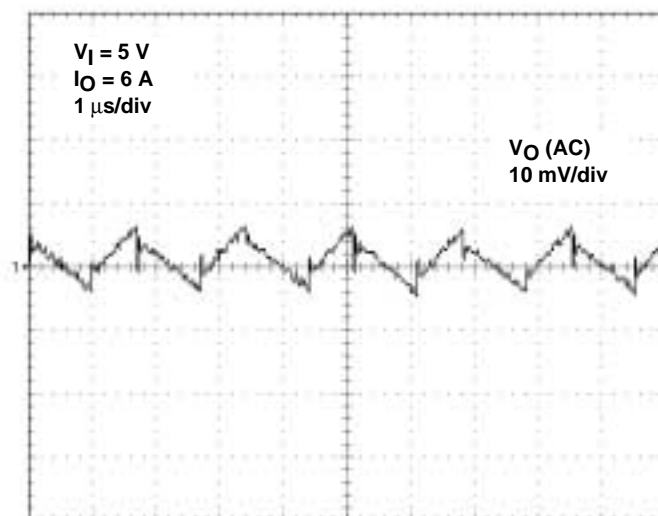

Figure 2–12. Measured Output Voltage Ripple With 5.0-V Input



## 2.8 Input Voltage Ripple

The input voltage ripple for a 6-A load is shown in Figure 2–13 for a 3.3-V input and in Figure 2–14 for a 5.0-V input. With a 5.0-V input, the ripple is approximately 260 mVpp. The input voltage ripple can be made lower by adding capacitance to the input.

Figure 2–13. Measured Input Voltage Ripple With 3.3-V Input

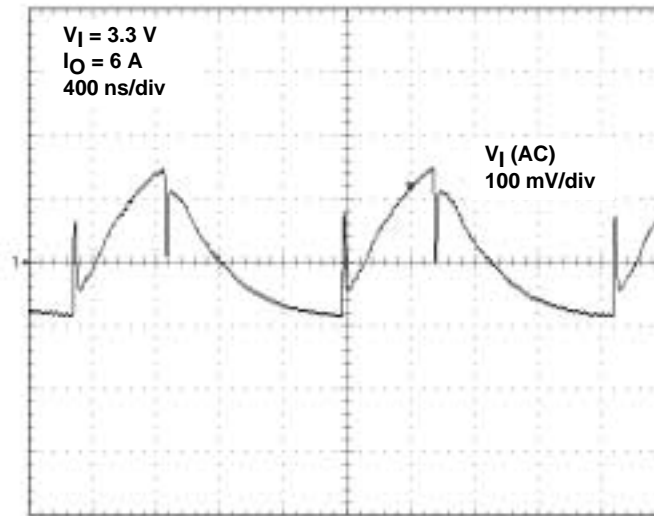
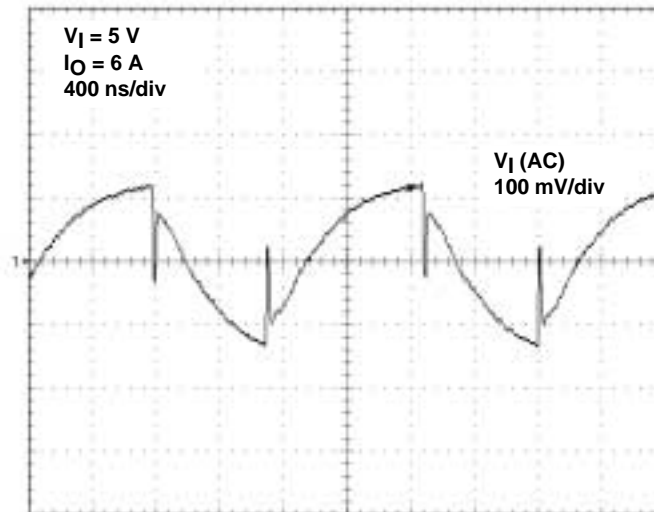

Figure 2–14. Measured Input Voltage Ripple With 5.0-V Input



## 2.9 Start-Up

The start-up voltage waveform of the TPS54614 EVM is shown in Figure 2–15. The TPS54614 output begins to rise when the input rises above the 3.0-V startup level. The output voltage then ramps linearly to 1.8 V in 3.6 ms. The start-up time is independent of input voltage and load. The slow start time can be made slower by using an external slow start capacitor (C6).

Figure 2–15. Measured Start-Up Waveforms

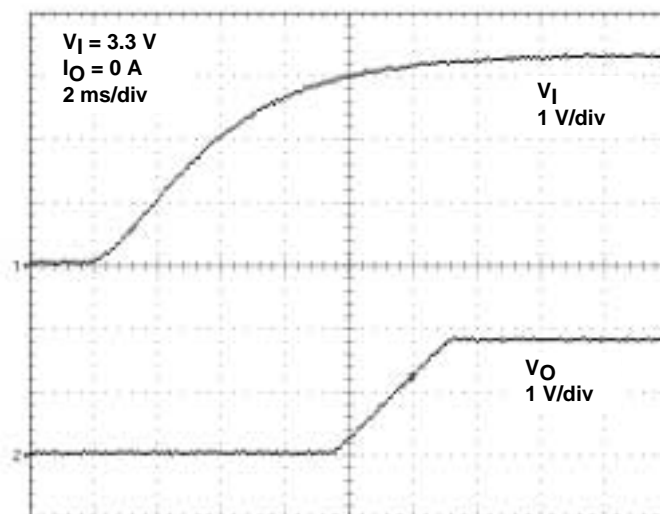

# Board Layout



This chapter provides the TPS54614 EVM board layout illustrations.

Topic	Page
3.1 Layout .....	3-2

### 3.1 Layout

The board layout for the TPS54614 EVM, shown in Figure 3–1 through Figure 3–4, resembles a layer stack-up encountered in a typical application. The top and bottom layers are 1.5 oz. copper, while the two internal layers are 0.5 oz. copper. The circuit components are confined to a small area of the circuit board. The two internal layers are identical and are used as *quiet* ground planes. The power ground plane is routed on the top layer, and is tied to the *quiet* (analog) ground planes at the output sense point (test point TP3). A wide power ground plane is used to keep the input ground current from injecting noise between the analog and power grounds. A total of 14 vias are used to tie the thermal land area under the TPS54614 to the internal ground planes and to the thermal plane on the back side of the board. The thermal plane on the back side occupies only the area directly underneath the regulator components, but should be made as large as possible in an actual application.

Figure 3–1. Top-Side Assembly

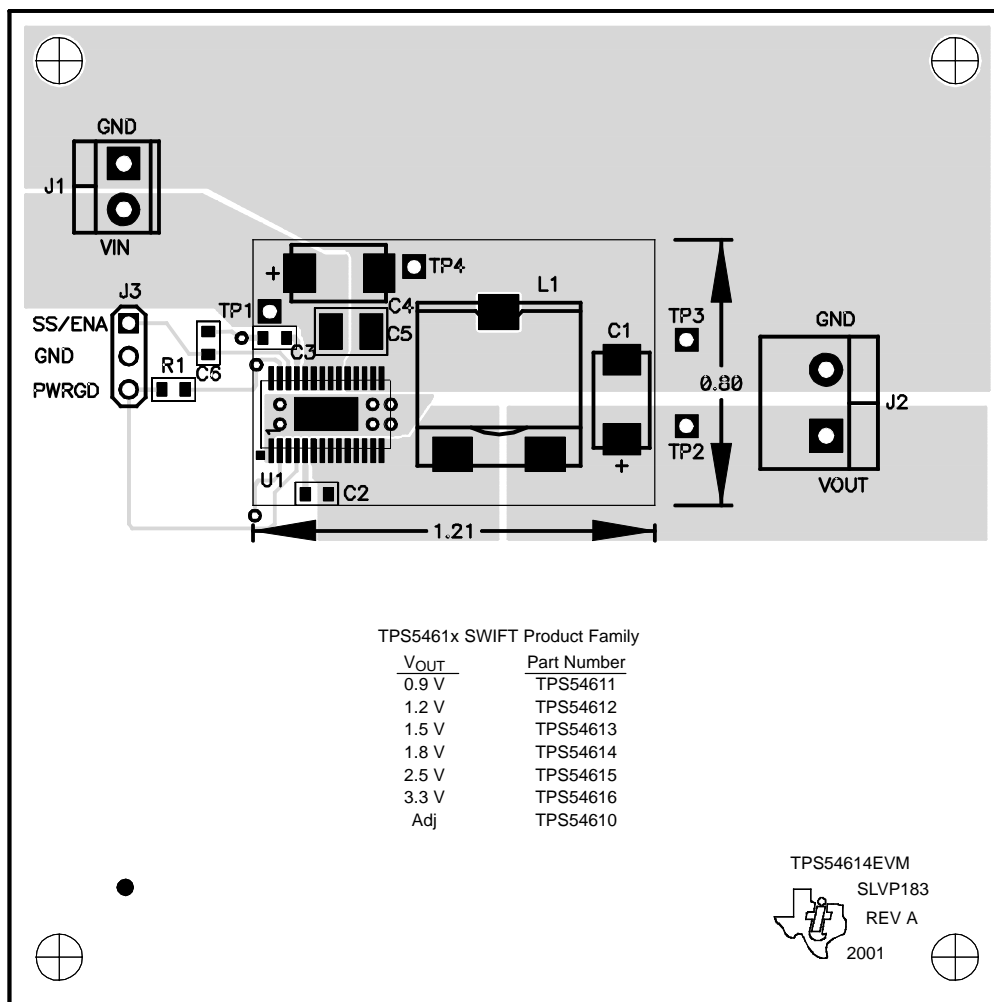



Figure 3-2. Top-Side Layout

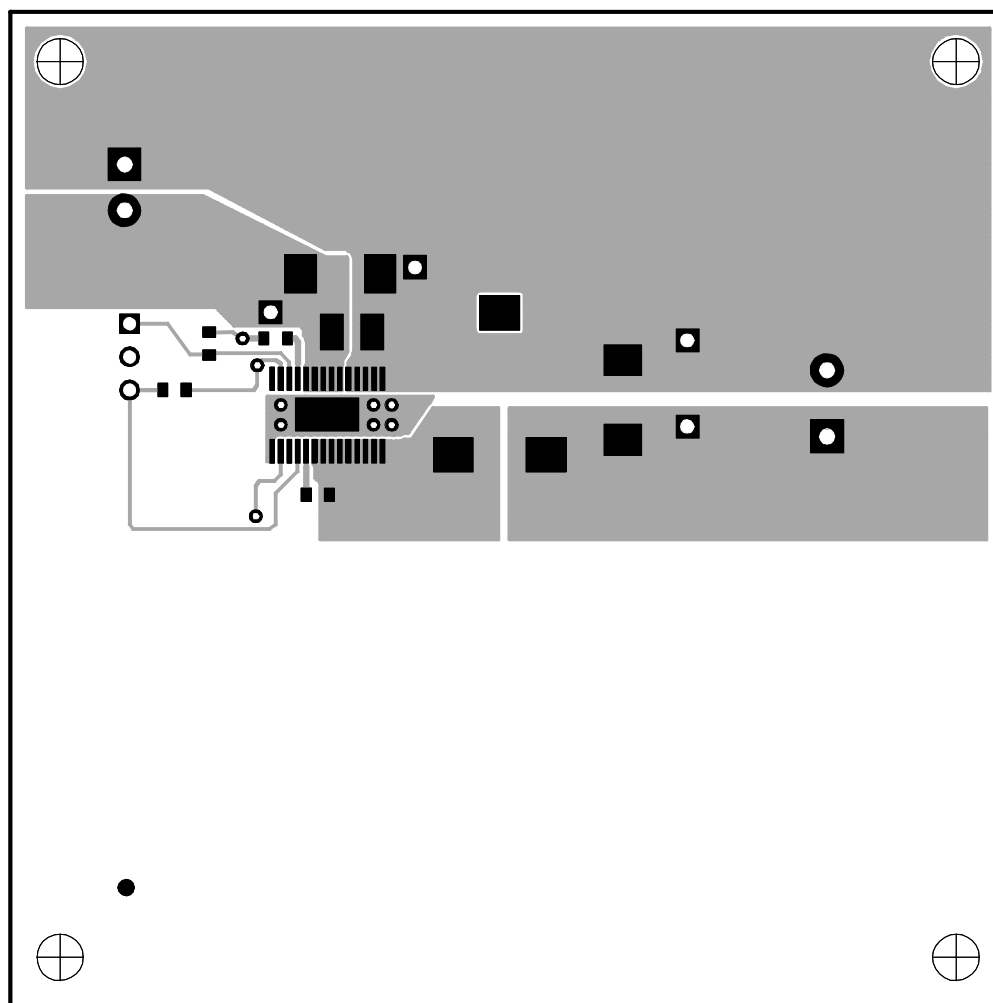
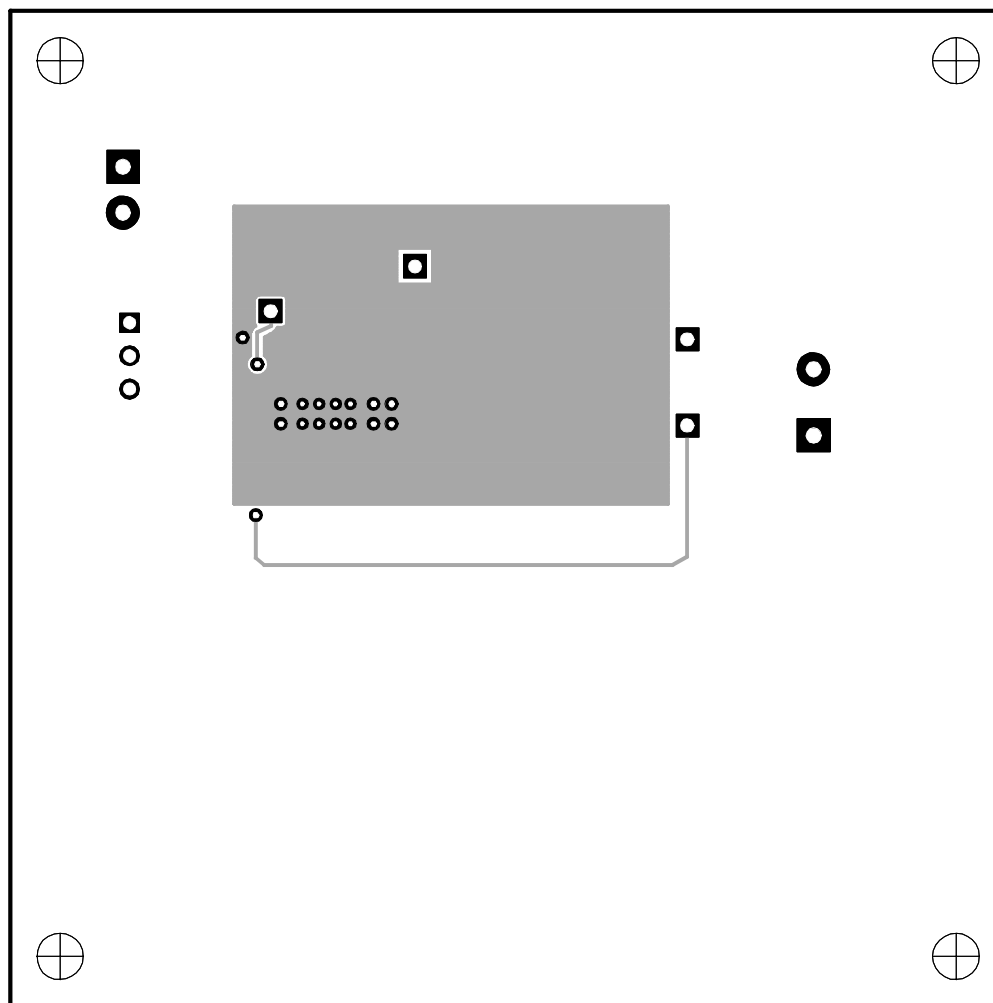



Figure 3–4. Bottom-Side Layout





# Schematic and Bill of Materials

---

---

---

---

This chapter provides a schematic diagram and bill of materials for the TPS54614 EVM.

<b>Topic</b>	<b>Page</b>
<b>4.1 Schematic</b> .....	<b>4-2</b>
<b>4.2 Bill of Materials</b> .....	<b>4-3</b>

## 4.1 Schematic

Figure 4–1. EVM Schematic

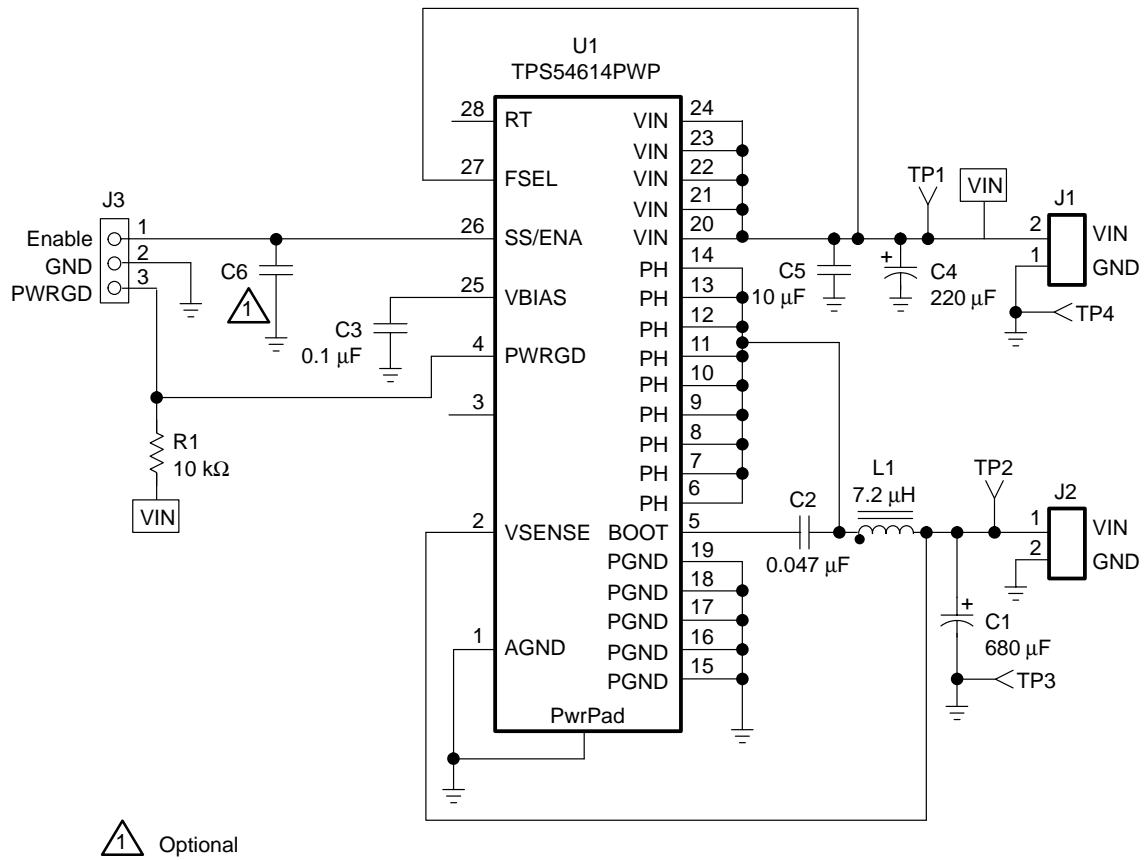

## 4.2 Bill of Materials

Table 4–1. TPS54614 EVM Bill of Materials

Count	Ref Des	Description	Size	MFR	Part Number
1	C1	Capacitor, POSCAP, 680- $\mu$ F, 2.5-V, 40-m $\Omega$ , 20%	7343 (D)	Sanyo	2R5TPB680M
1	C2	Capacitor, ceramic, 0.047- $\mu$ F, 25-V, X7R, 10%	603	Murata	GRM39X7R473K25
1	C3	Capacitor, ceramic, 0.1- $\mu$ F, 25-V, X7R, 10%	603	Murata	GRM39X7R104K25
1	C4	Capacitor, POSCAP, 220- $\mu$ F, 10-V, 40 m $\Omega$ , 20%	7343 (D)	Sanyo	10TPB220M
1	C5	Capacitor, ceramic, 10- $\mu$ F, 10-V, X5R, 20%	1210	Panasonic	ECJ–4YB1A106K
–	C6	Open (Unpopulated)	603		
1	J1	Terminal block, 2-pin, 6-A, 3,5 mm	0.27 $\times$ 0.25	OST	ED1514
1	J2	Terminal block, 2-pin, 15-A, 5,1 mm	0.40 $\times$ 0.35	OST	ED1609
1	J3	Header, 3-pin, 100 mil spacing, (36-pin strip)	0.100 x 3	Sullins	PTC36SAAN
1	L1	Inductor, SMT, 7.2- $\mu$ H, 7.8-A, 13.5 m $\Omega$	0.492 sq	Sumida	CEP125(H)–7R2
1	R1	Resistor, Chip, 10 k $\Omega$ , 1/16-W, 1%	603	Std	Std
2	TP1, TP2	Test Point, red, 1mm	0.038	Farnell	240–345
2	TP3, TP4	Test Point, black, 1mm	0.038	Farnell	240–333
1	U1	IC, SWIFT™ power controller, 1.8-V, 6-A	PWP28	TI	TPS54614PWP
1	—	Shunt, 100-mil, black	0.100	3M	929950–00
1	NA	PWB, 4 layers, 1 1/2 ounce copper	3.00 $\times$ 3.00	Any	SLVP183

